

Jerry Can Holder Kit – Fitting Guide

Thank you for purchasing the Out-Rack Jerry Can Holder Kit. It has been developed to offer maximum flexibility of use, maintaining the best characteristics of lightness and strength.

This Kit must be necessarily used with two Jerry Can, it cannot be used with a single can or with other kind of tank than those previously described.

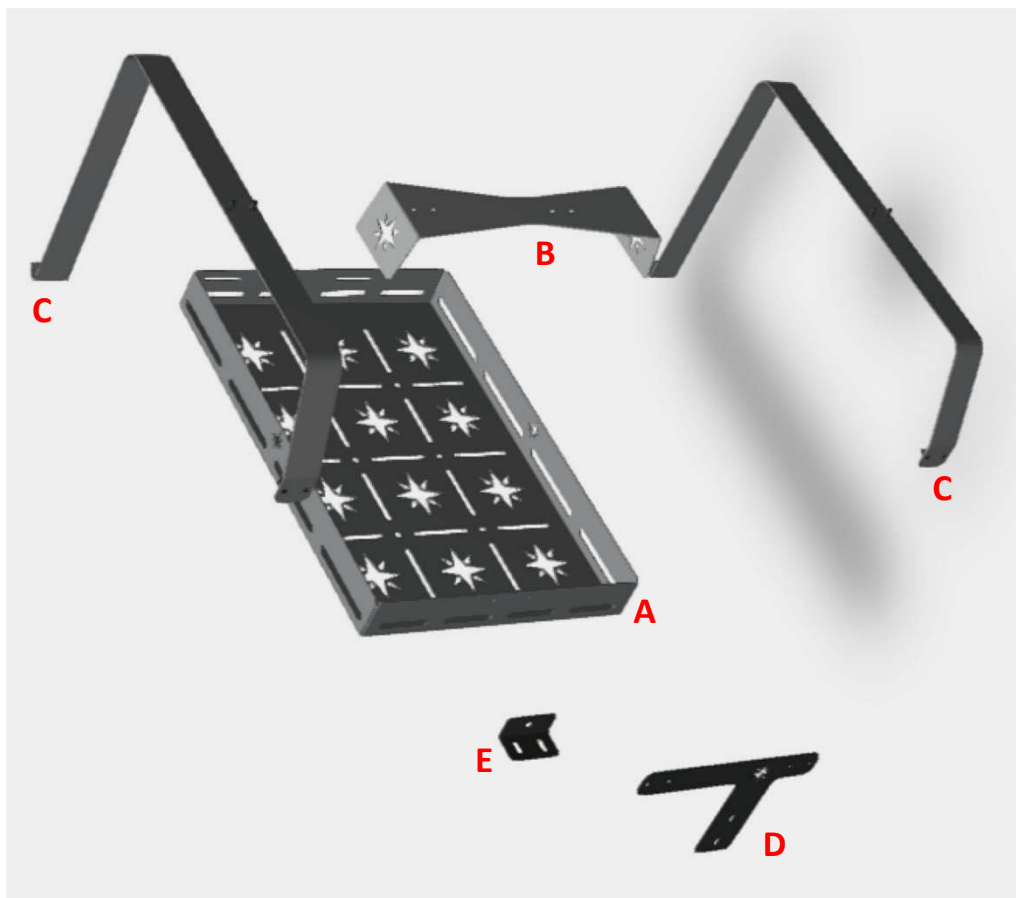

Kit Contents:

- Nr. 1 tray - **A**
- Nr. 1 upper bracket - **B**
- Nr. 2 suspenders - **C**
- Nr. 1 front bracket- **D**
- Nr. 4 corner brackets -**E**
- Nr. 1 hinge closure **F**
- Nr. 11 self locking nuts M5
- Nr. 3 stainless steel round head screws M5
- Nr. 9 stainless steel screws M6
- Nr. 9 self locking nuts M6
- Nr. 9 washers
- Nr. 4 stainless steel bolts M8
- Nr. 4 self locking nuts M8
- Nr. 8 washers M8

Required tools:

- Spanner 8mm
- Spanner 10mm
- Spanner 13mm

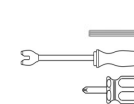

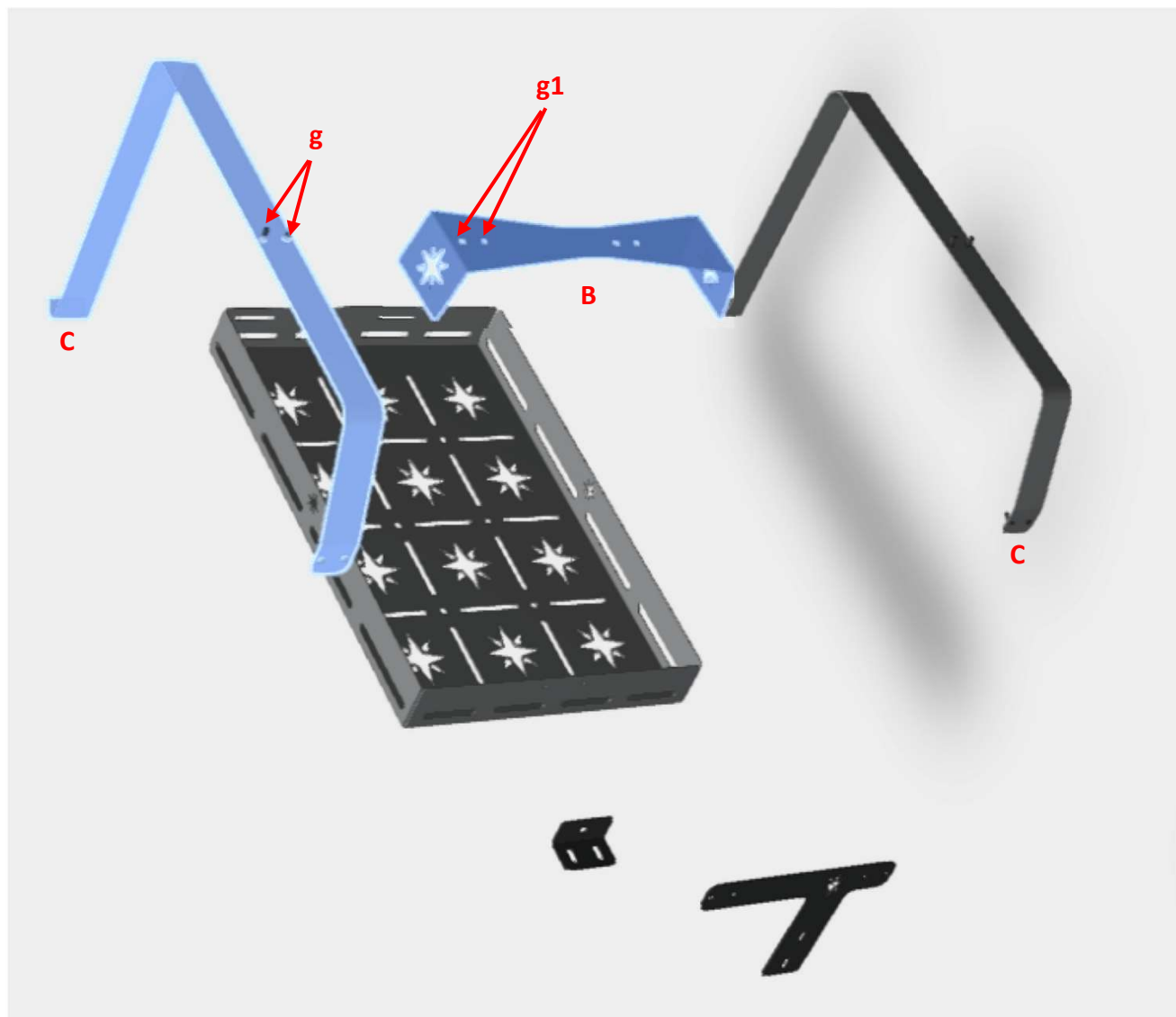

1. Insert the upper threaded pins **g** (on the suspender **C**) inside the holes **g1** (on the upper bracket **B**)
1. Tighten the joint with the M5 nuts supplied.
2. Repeat the procedure with the other suspender **C**

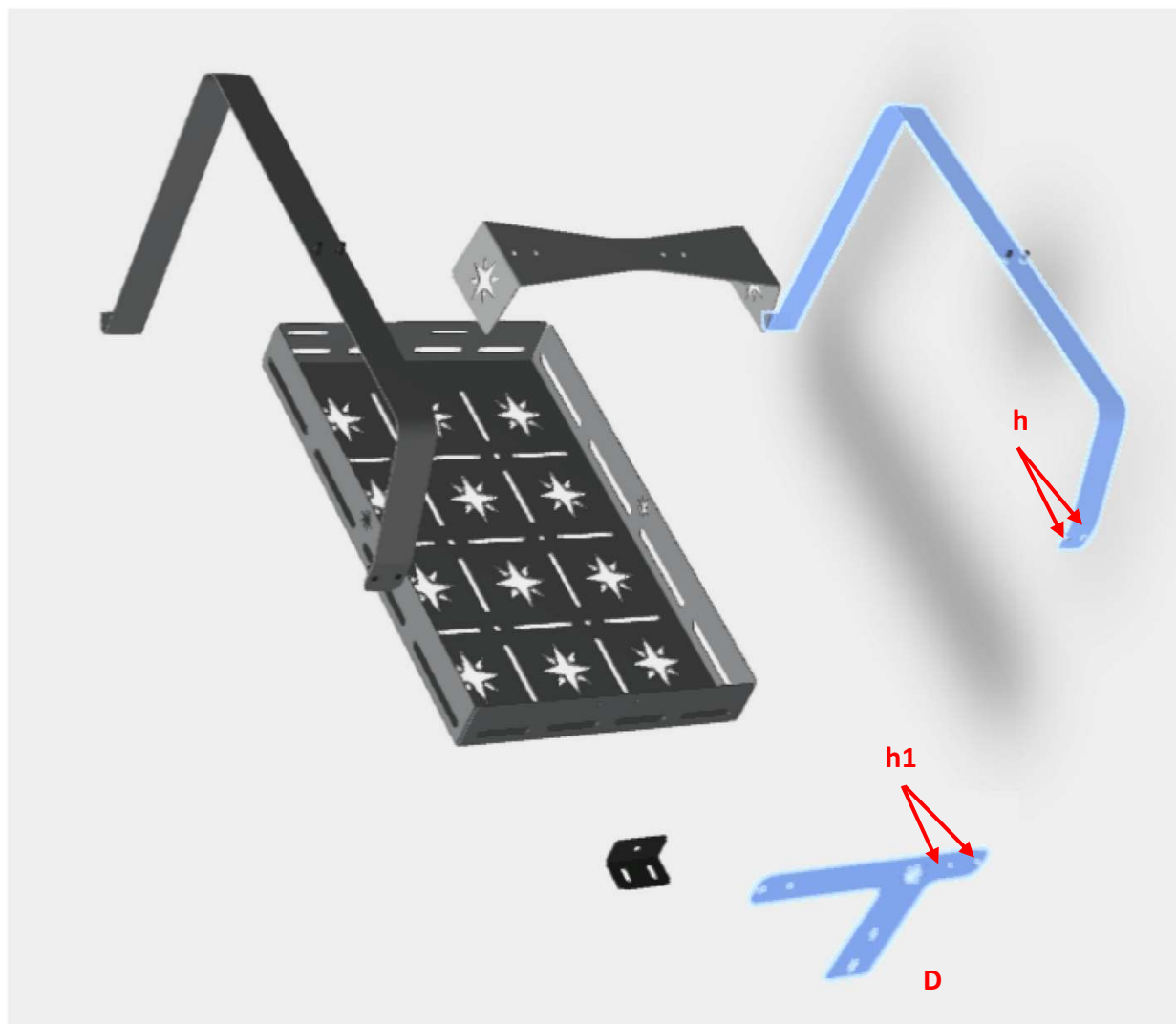

4. Insert the lower threaded pins **h** (on the suspender **C**) inside the holes **h1** (present on the lower bracket **D**).
5. Tighten the joint with the M5 nuts supplied.
6. Repeat the procedure with the other suspender **C**

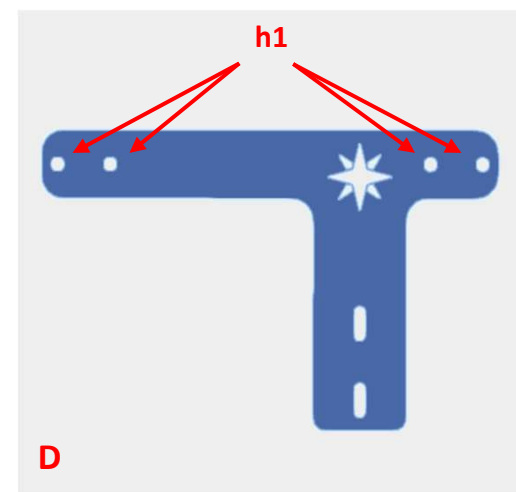

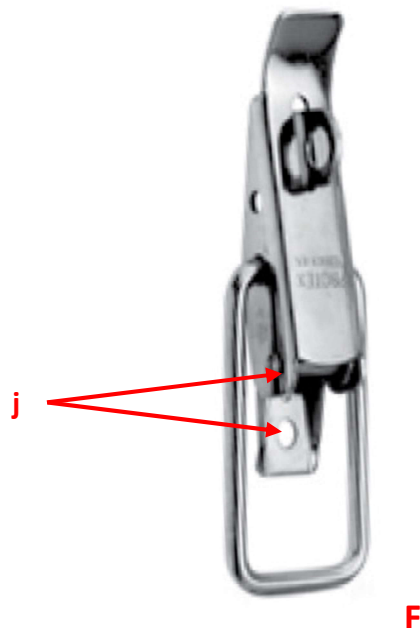
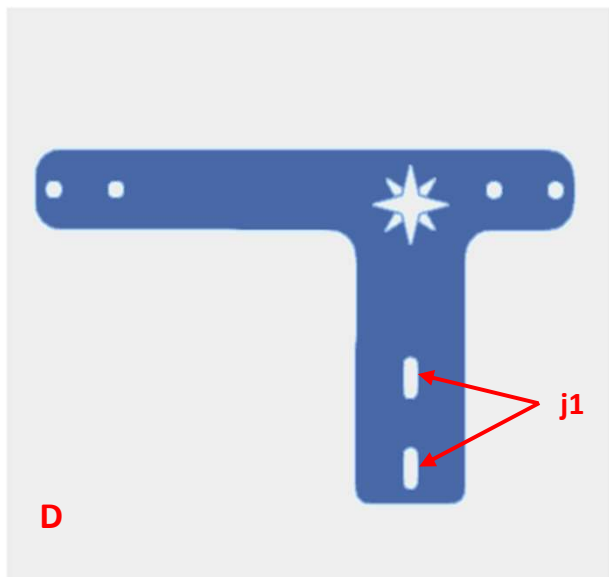

7. Tighten the hinge closure **F** to the front bracket **D** centering the holes **j** with the slots **j1**.
8. Insert the 2 round head screws supplied, in the holes **j** (hinge closure **F**), adjust the height and tighten the joint with the supplied M5 nuts .

Jerry Can Holder Kit – Fitting Guide

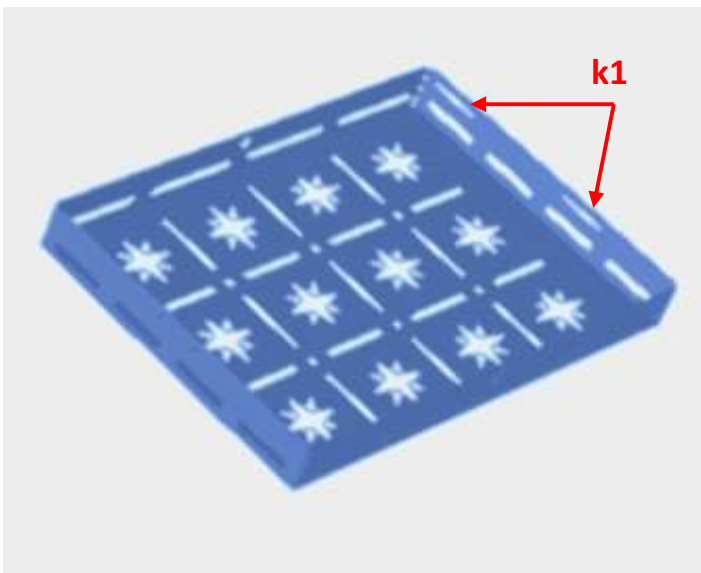

9. Insert the curved part **k** of the Suspender (**C**) into the slots **k1** of the tray (**A**).
10. Insert 2 Jerry Can, adjust if necessary the height of the closure **F** by loosening and tightening again the nuts between **j** - **j1** and that's it.

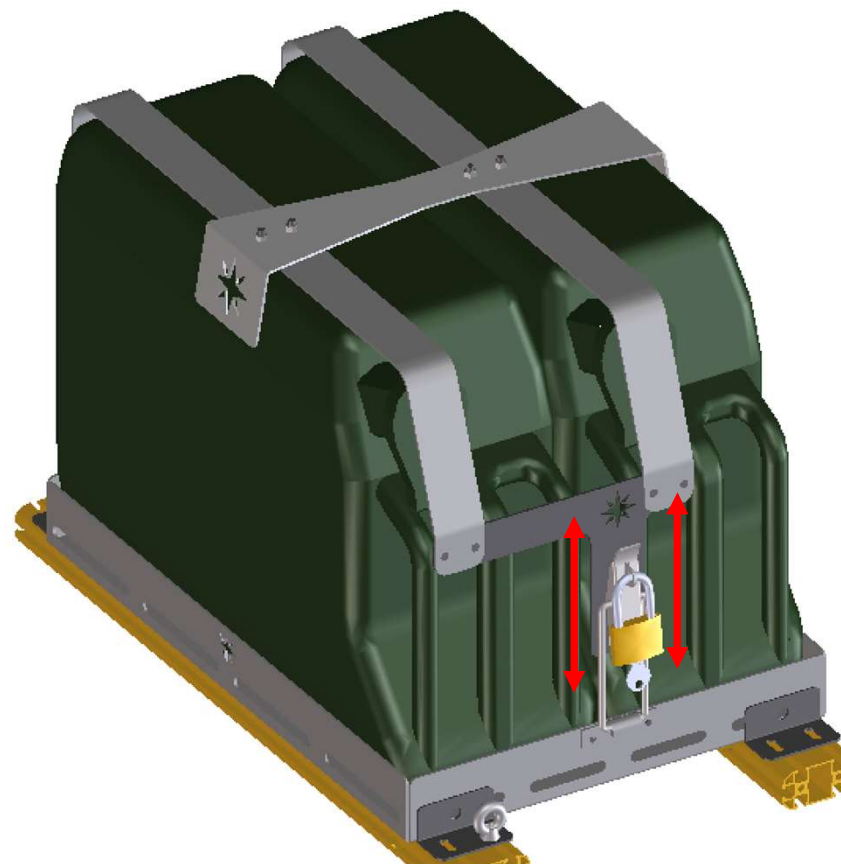

Jerry Can Holder Kit – Fitting Guide

11. The Kit contains 4 corner brackets **E**, which can be used to fix the Jerry Can Holder to the loading surface of your roof rack, using the supplied M6 and M8 screws, nuts and washers .

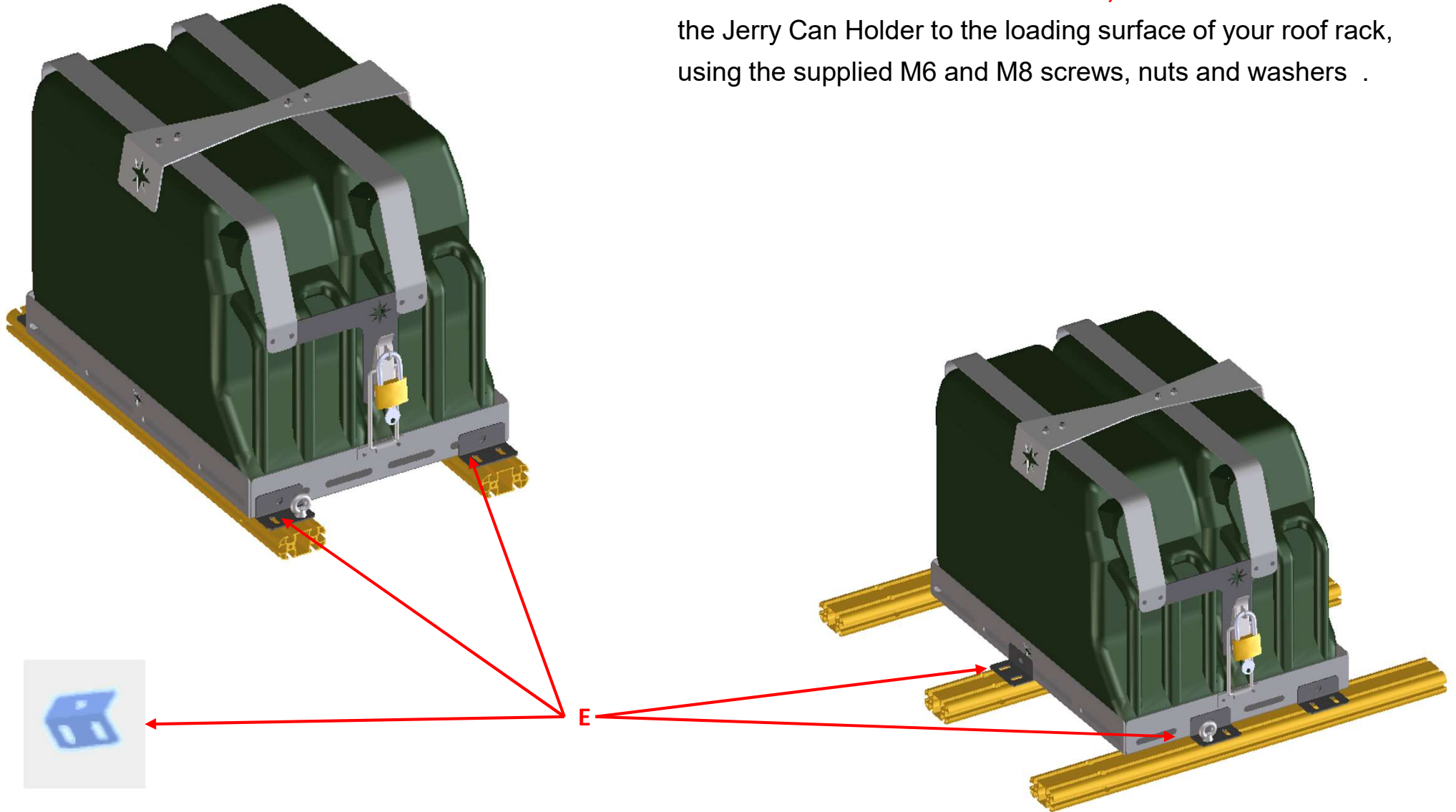

Congratulation! Your Out-Rack Jerry Can Holder is ready for your adventures!





CAUTION!

Periodically check the proper tightening of all the parts

Jerry Can Holder Kit – Fitting Guide

Out-Rack offers a range of accessories to install on your roof rack such as: Brackets for CB Antenna, Led bar, adjustable and fix working lights and much more.

For further information please contact us: info@out-rack.com

